

Kompakt-Ventile LPP700
Magnetventile 18 mm

Compact Valves LPP700
Solenoid Valves 18 mm Width

5/2-Wege monostabil

5/2-Way Monostable Solenoid

LPP772

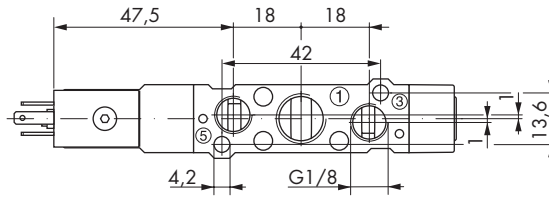
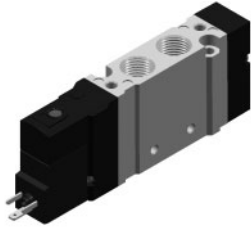

77.212.90.00

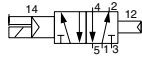

77.212.91.00

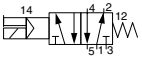

77.232.90.00

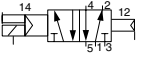

77.232.91.00

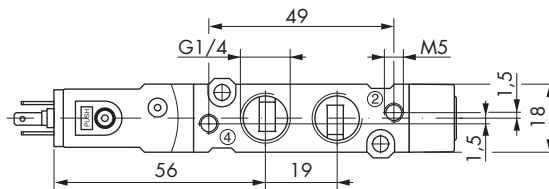
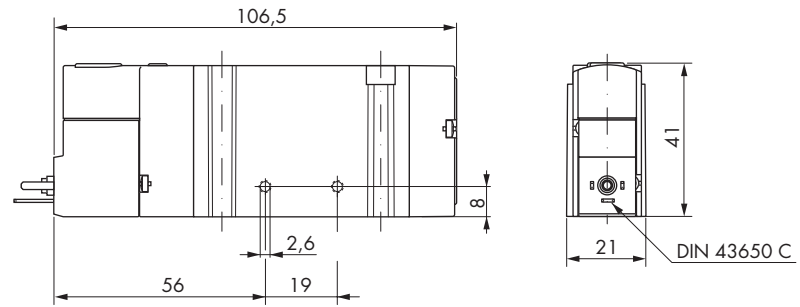
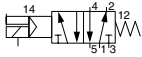

LPP772

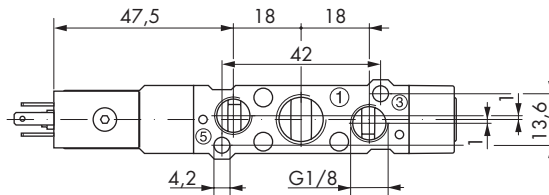
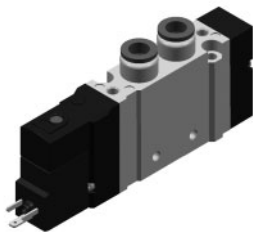

77.214.90.00

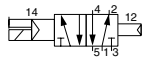

77.214.91.00

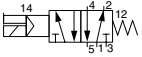

77.234.90.00

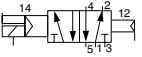

77.234.91.00

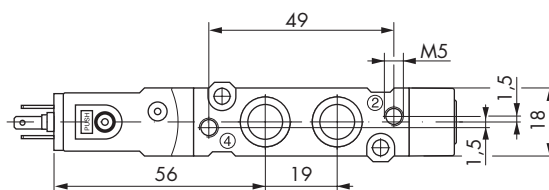
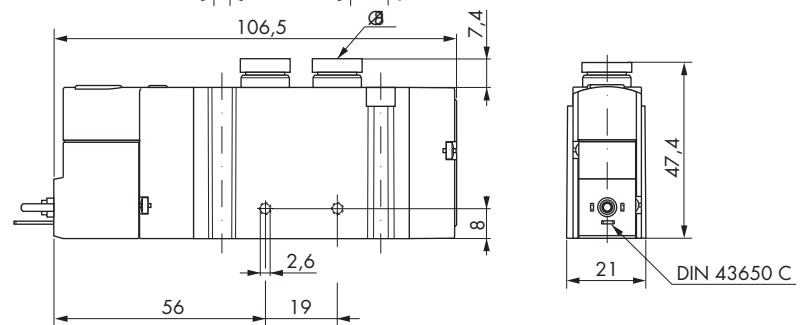
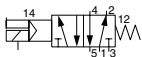

Kompakt-Ventile LPP700
Magnetventile 18 mm

Compact Valves LPP700
Solenoid Valves 18 mm Width

5/2-Wege bistabil

5/2-Way Bistable Solenoid

LPP772

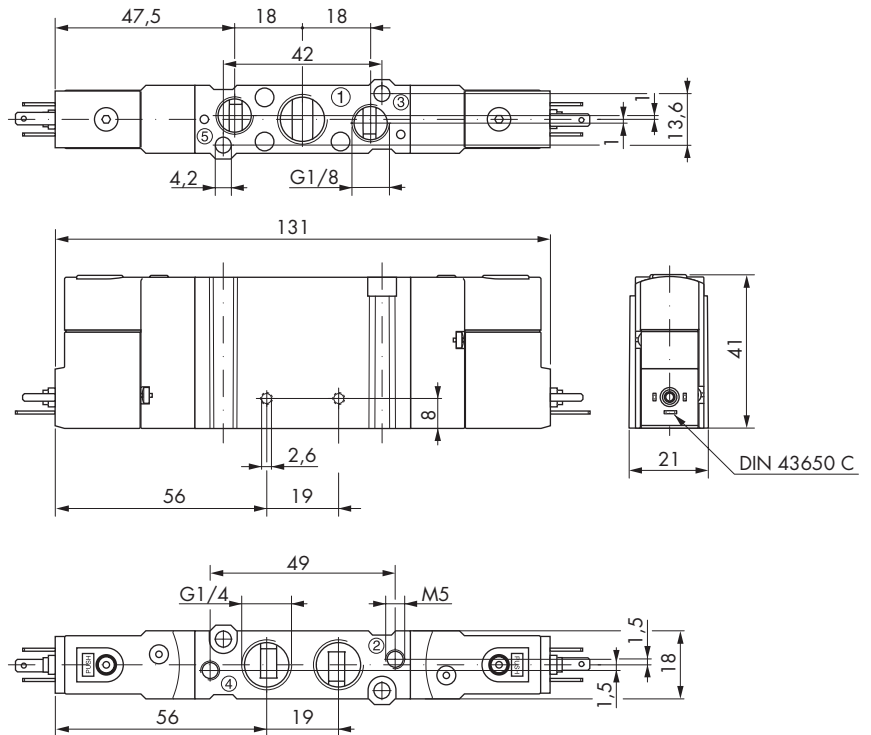
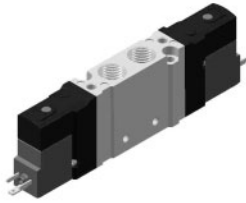

77.212.92.00



77.212.93.00

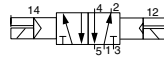

77.232.92.00

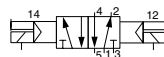

77.232.93.00

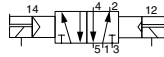

LPP772

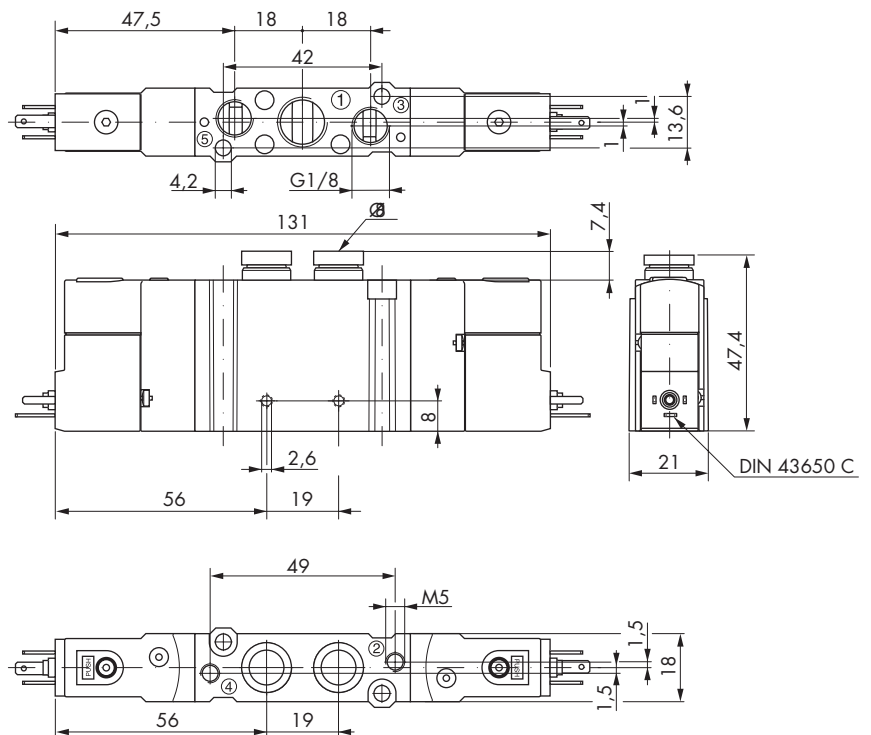
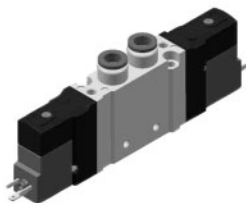

77.214.92.00



77.214.93.00

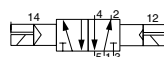

77.234.92.00

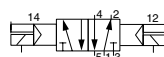

77.234.93.00



Kompakt-Ventile LPP700
Magnetventile 18 mm

Compact Valves LPP700
Solenoid Valves 18 mm Width

5/3-Wege

5/3-Way

LPP772

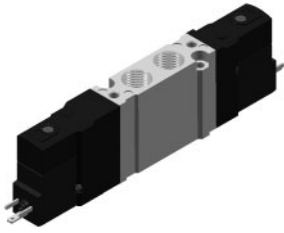

77.212.12.00

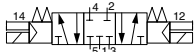

77.232.12.00

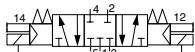

77.212.22.00



77.232.22.00



77.212.32.00

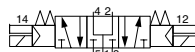

77.232.32.00

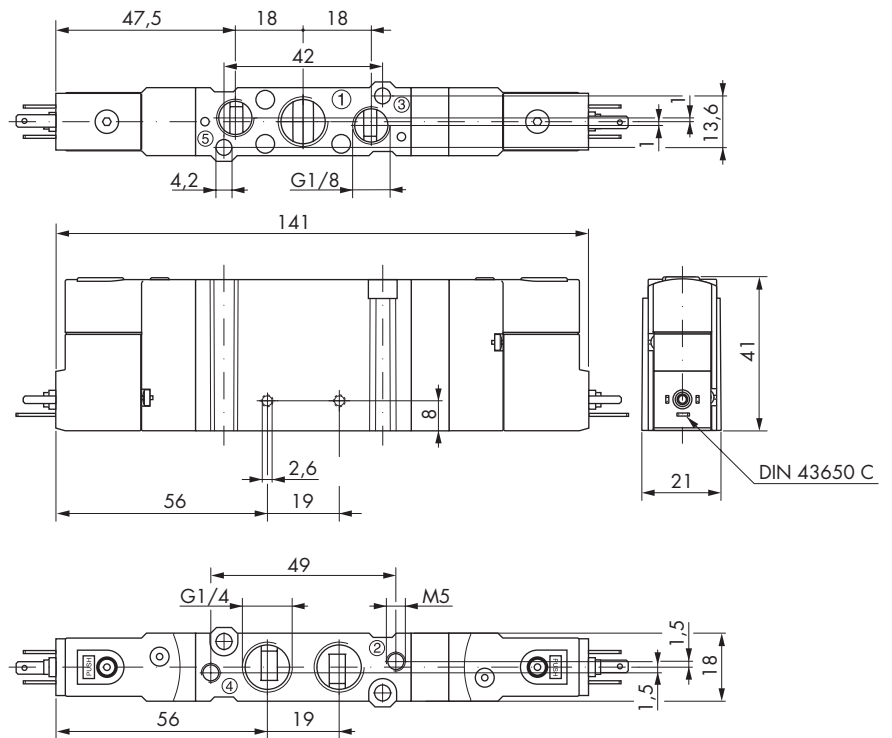
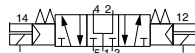

LPP772

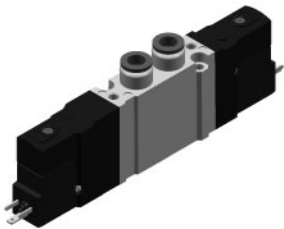

77.214.12.00

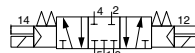

77.234.12.00

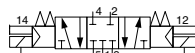

77.214.22.00



77.234.22.00



77.214.32.00

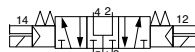

77.234.32.00

